

MAREA

IT - Gli articoli della serie Marea sono disponibili nelle finiture sotto indicate:

CR	Cromo	DB	Bronzo scuro*
GI	Ottone lucido	DC	Rame scuro*
CD	Cromo oro	NA	Nichel antico*
BR	Bronzato*	DO	Dorato
RA	Ramato*		

*Le collezioni prodotte con finiture spazzolate vengono realizzate interamente a mano. Tale processo conferisce alla finitura una speciale discontinuità, rendendo ogni pezzo unico ed esclusivo.

IMPORTANTE: Nella cura dei prodotti Porta & Bini si devono utilizzare soltanto i prodotti di pulizia che sono espressamente previsti per questo campo d'impiego. Non utilizzare prodotti ausiliari e attrezzi per la pulizia con effetto abrasivo, come abrasivi inadatti, spugne e panni in microfibra.

GB - The articles included in Marea series are available in the following finishings:

CR	Chrome	DB	Dark bronze*
GI	Natural brass	DC	Dark copper*
CD	Chrome gold	NA	Old nickel*
BR	Bronze*	DO	Gold
RA	Copper*		

*The brushed finishing collections are made entirely by hand. This mean that their discontinuous shade may be visible. These distinct characteristics contribute to making each piece unique and exclusive.

IMPORTANT: With regard to caring for the Porta & Bini products, only use cleaning material which is explicitly provided for this type of application. Never use cleaning materials or appliances with an abrasive effect, such as unsuitable cleaning powders, sponge pads or micro fibre cloths.

FR - Les articles de la série Marea sont disponibles en finitions indiquées ci-dessous :

CR	Chrome	DB	Bronze foncé*
GI	Laiton poli	DC	Cuivre foncé*
CD	Chrome or	NA	Nickel antique*
BR	Bronzé*	DO	Doré
RA	Cuivré*		

*Les collections avec des finitions brossées sont entièrement réalisées à la main. Grâce à ce procédé, la finition acquiert une discontinuité particulière en rendant chaque pièce unique et exclusive.

IMPORTANT : Lors de l'entretien des articles Porta & Bini, seuls les produits de nettoyage expressément prévus pour ce type d'entretien doivent être utilisés. Ne pas utiliser d'autres produits ou d'outils de nettoyage ayant un effet abrasif, tels que les abrasifs inappropriés, éponges ou chiffons en microfibra.

DE - Die Artikel der Serie Marea sind in den unten aufgeführten Fertigbearbeitungen erhältlich:

CR	Chrom	DB	Dunkle Bronze*
GI	Poliertes Messing	DC	Dunkles Kupfer*
CD	Goldverchromt	NA	Antikes Nickel*
BR	Brüniert*	DO	Vergoldet
RA	Kupfer*		

*Die mit gebürsteten Oberflächen hergestellten Kollektionen werden vollständig von Hand gefertigt. Dieser Prozess verleiht dem Finish eine besondere Diskontinuität, wodurch jedes Stück einzigartig und exklusiv wird.

WICHTIG: Für die Pflege der Produkte Porta & Bini dürfen nur die Reinigungsmittel verwendet werden, welche ausdrücklich für diesen Anwendungsbereich vorgesehen sind. Keine abrasiven Hilfsprodukte und Reinigungswerkzeuge verwenden, wie ungeeignete Schleifmittel, Schwämme und Mikrofasertücher.

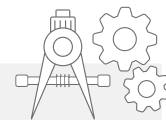
IT - SPECIFICHE TECNICHE

- > Temperatura di utilizzo massima 80°C, consigliata 60°C.
- > Pressione di alimentazione ottimale 3 bar continui.
- > Differenza pressione massima acqua calda/fredda 1 bar consigliata la minima possibile.
- > Nel caso di pressioni oltre i 5 bar, è consigliabile installare un riduttore di pressione.

NOTA: I tubetti flessibili vengono forniti come dotazione standard per una più facile installazione; i tubetti rigidi sono disponibili come un accessorio opzionale o su previa richiesta.

Per garantire l'ottimale funzionamento del prodotto si consiglia l'installazione di rubinetti filtro sottolavabo ispezionabili Porta & Bini articoli: 00538, 00539 e 00540.

GB - TECHNICAL SPECIFICATION

- > Temperature range max 80°C, recommended 60°C.
- > Optimal water supply pressure 3 bar continual.
- > Difference of hot/cold pressure max 1 bar recommended minimum possible.
- > In the event of pressure over 5 bar, install a centralized pressure reducer.

NOTE: Stainless steel hoses are provided as standard equipment for easy installation; copper supply tubes are available as an optional accessory or with advance notice.

In order to allow optimal product operation is recommended to connect hot and cold waterlines to the angle stop filter valves Porta & Bini items code: 00538, 00539 and 00540.

FR - SPÉCIFICATIONS TECHNIQUES

- > Température d'utilisation maximale 80°C, conseillée 60°C.
- > Pression d'alimentation optimale 3 bar continue.
- > Différence de pression max de l'eau chaude/froide 1 bar, la différence conseillée - la plus petite possible.
- > En cas des pressions supérieures à 5 bar, il est conseillé d'installer un réducteur de pression.

NOTE : Les tubes flexibles sont fournis avec l'équipement standard pour une installation plus facile ; les tubes rigides sont disponibles en option ou sur demande.

Afin de garantir le fonctionnement optimal du produit, il est conseillé d'installer les robinets avec filtre sous lavabo inspectables Porta & Bini articles: 00538, 00539 et 00540.

DE - TECHNISCHE SPEZIFIKATIONEN

- > Maximale Gebrauchstemperatur 80°C, empfohlene Temperatur 60°C.
- > Der optimale Versorgungsdruck liegt bei durchgehend 3 bar.
- > Als maximaler möglicher Druckunterschied bei Heiß-/Kaltwasser wird als Mindestwert 1 bar empfohlen.
- > Bei einem Wasserdruck von über 5 bar ist es ratsam, ein Druckminderventil einzubauen.

ANMERKUNG: Die Schläuche werden zur einfacheren Installation als Standardausrüstung mitgeliefert; Die starren Rohrleitungen sind als optionales Zubehör oder auf vorhergehende Anfrage erhältlich.

Um die optimale Funktionsfähigkeit des Produktes zu gewährleisten, empfiehlt sich die Installation von inspezierbaren Untertisch-Filtereckventilen der Firma Porta & Bini, Artikel: 00538, 00539 und 00540.

Marea

MAREA



pag 379



pag 330



pag 406



pag 388



pag 317



pag 409



pag 362



pag 551

MAREA

IT - Porta & Bini si riserva il diritto di apportare eventuali modifiche ai propri prodotti senza preavviso. Le dimensioni raffigurate all'interno delle rappresentazioni grafiche sono da ritenersi indicative e soggette a possibili variazioni. In caso di domande si prega di contattare il proprio fornitore autorizzato Porta & Bini.

GB - Porta & Bini has the right to modify its products without any notice. All dimensions are based on original specification and are subject to change and variation. Please consult your Porta & Bini Design Associate for current specifications.

FR - Porta & Bini se réserve le droit de modifier ses propres produits sans préavis. Les dimensions indiquées dans les représentations graphiques sont données à titre indicatif et sont susceptibles d'être modifiées. En cas de doutes veuillez contacter votre livreur autorisé Porta & Bini.

DE - Das Unternehmen Porta & Bini behält sich das Recht vor, Änderungen an seinen Produkten ohne vorherige Ankündigung vorzunehmen. Die in den grafischen Darstellungen dargestellten Abmessungen sind als Richtwerte zu betrachten und unterliegen möglichen Abweichungen. Bei Fragen wenden Sie sich bitte an Ihren, von Porta & Bini autorisierten Lieferanten.

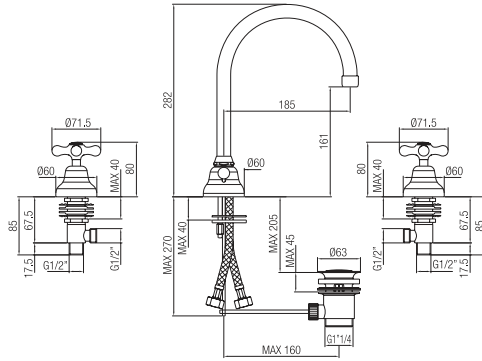

30212..

Finiture - Finishes

CR - GI

CD

BR - RA

DB - DC - NA

DO

30512..

IT - vitone ceramico.

GB - ceramic valve.

FR - tête céramique.

DE - Oberteil Keramik.

CR - GI

CD

BR - RA

DB - DC - NA

DO

IT - Batteria lavabo bocca girevole con scarico canna a fontana.
 GB - Basin set with swivel spout and pop up waste fountain spout.
 FR - Mélangeur lavabo bec pivotant avec décharge bec à fontaine.
 DE - Batterie für Waschbecken, Schwenkauslauf mit Ablauf Brunnenauslauf.

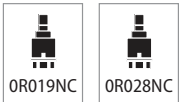

30156..

Finiture - Finishes

CR - GI

CD

BR - RA

DB - DC - NA

DO

30556..

IT - vitone ceramico.

GB - ceramic valve.

FR - tête céramique.

DE - Oberteil Keramik.

CR - GI

CD

BR - RA

DB - DC - NA

DO

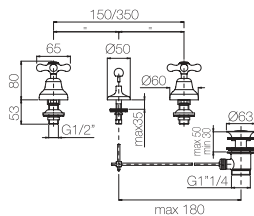

IT - Combinazione bidet con scarico.
 GB - Bidet set with pop up waste.
 FR - Combinaison bidet avec décharge.
 DE - Kombination Bidet mit Ablauf.

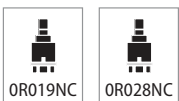

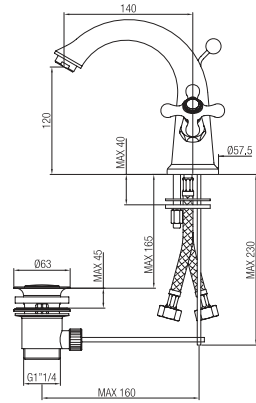

IT - Monoblocco lavabo modello alto con scarico automatico.
 GB - Basin high model monobloc with pop up waste.
 FR - Monobloc lavabo modèle haut avec décharge automatique.
 DE - Hoher Monoblock Waschbecken mit automatischem Ablauf.

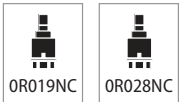

30310.. Finiture - Finishes

- CR - GI
- CD
- BR - RA
- DB - DC - NA
- DO

30510..

IT - vitone ceramico.
 GB - ceramic valve.
 FR - tête céramique.
 DE - Oberteil Keramik.

- CR - GI
- CD
- BR - RA
- DB - DC - NA
- DO

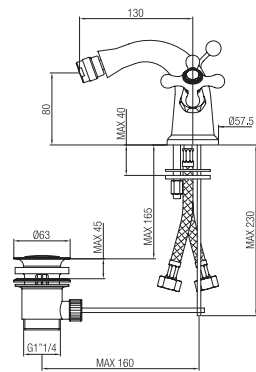

IT - Monoblocco bidet modello alto con scarico automatico.
 GB - Bidet high model monobloc with pop up waste.
 FR - Monobloc bidet modèle haut avec décharge automatique.
 DE - Hoher Monoblock Bidet mit automatischem Ablauf.

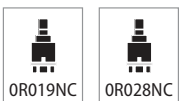

30320.. Finiture - Finishes

- CR - GI
- CD
- BR - RA
- DB - DC - NA
- DO

30520..

IT - vitone ceramico.
 GB - ceramic valve.
 FR - tête céramique.
 DE - Oberteil Keramik.

- CR - GI
- CD
- BR - RA
- DB - DC - NA
- DO

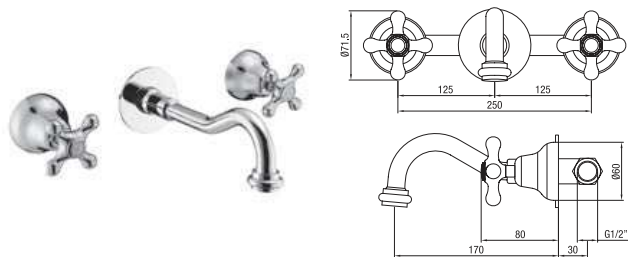

IT - Batteria lavabo a muro. L 160 mm.
 GB - Wall basin set. L 160 mm.
 FR - Mélangeur lavabo montage mural. L 160 mm.
 DE - Batterie für Waschbecken, Wandmontage. L 160 mm.

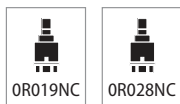

30242..

Finiture - Finishes

- CR - GI
- CD
- BR - RA
- DB - DC - NA
- DO

30542..

IT - vitone ceramico.
 GB - ceramic valve.
 FR - tête céramique.
 DE - Oberteil Keramik.

- CR - GI
- CD
- BR - RA
- DB - DC - NA
- DO



IT - Batteria lavabo a muro. L 200 mm.
 GB - Wall basin set. L 200 mm.
 FR - Mélangeur lavabo montage mural. L 200 mm.
 DE - Batterie für Waschbecken, Wandmontage. L 200 mm.

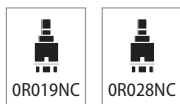

30243..

Finiture - Finishes

- CR - GI
- CD
- BR - RA
- DB - DC - NA
- DO

30543..

IT - vitone ceramico.
 GB - ceramic valve.
 FR - tête céramique.
 DE - Oberteil Keramik.

- CR - GI
- CD
- BR - RA
- DB - DC - NA
- DO

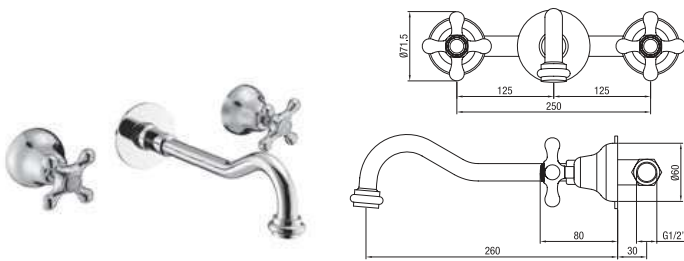

IT - Batteria lavabo a muro. L 250 mm.
 GB - Wall basin set. L 250 mm.
 FR - Mélangeur lavabo montage mural. L 250 mm.
 DE - Batterie für Waschbecken, Wandmontage. L 250 mm.

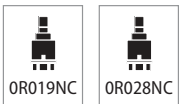

30244..

Finiture - Finishes

- CR - GI
- CD
- BR - RA
- DB - DC - NA
- DO

30544..

IT - vitone ceramico.
 GB - ceramic valve.
 FR - tête céramique.
 DE - Oberteil Keramik.

- CR - GI
- CD
- BR - RA
- DB - DC - NA
- DO

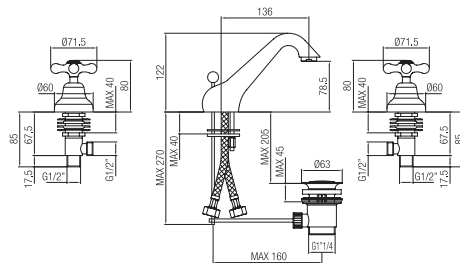

IT - Batteria lavabo con scarico automatico.
 GB - Basin set with pop up waste.
 FR - Mélangeur lavabo avec décharge automatique.
 DE - Batterie für Waschbecken mit automatischem Ablauf.

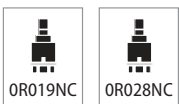

30202..

Finiture - Finishes

- CR - GI
- CD
- BR - RA
- DB - DC - NA
- DO

30502..

IT - vitone ceramico.
 GB - ceramic valve.
 FR - tête céramique.
 DE - Oberteil Keramik.

- CR - GI
- CD
- BR - RA
- DB - DC - NA
- DO

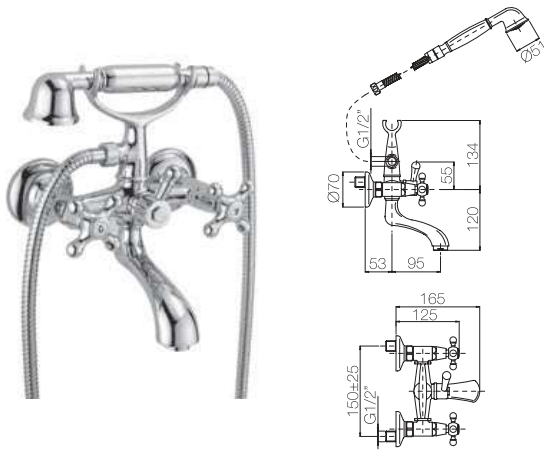

30200..

Finiture - Finishes

CR - GI

CD

BR - RA

DB - DC - NA

DO

30500..

IT - vitone ceramica.

GB - ceramic valve.

FR - tête céramique.

DE - Oberteil Keramik.

CR - GI

CD

BR - RA

DB - DC - NA

DO

IT - Gruppo vasca esterno con kit doccia.

GB - External bath set with shower kit.

FR - Groupe baignoire externe avec kit douche.

DE - Externe Badewannengruppe mit Bausatz für Duschen.

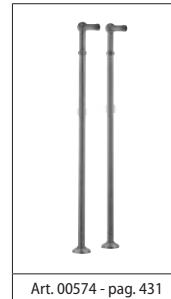

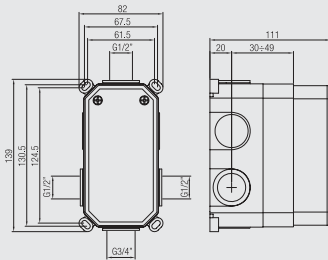

IT - Cassetta da incasso a muro universale.
 GB - Universal built-in shower box.
 FR - Boitier encastrable montage mural universel.
 DE - Universal-Einbauspülkasten Wandmontage.

01BOXNC

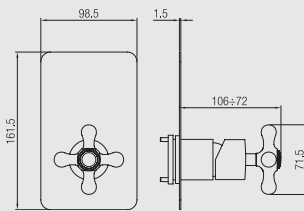

IT - Parti esterne monocomando doccia incasso.
 GB - External parts built-in shower mixer.
 FR - Parties externes monocommande douche encastrément.
 DE - Externe Bestandteile Einhebelmischer für Duschen Einbau.



30166..

Finiture - Finishes

CR - GI

CD

BR - RA

DB - DC - NA

DO

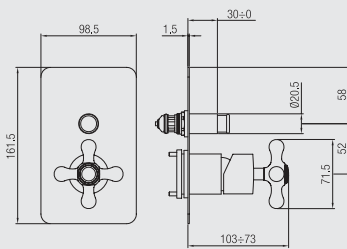
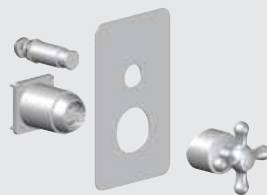

IT - Parti esterne monocomando doccia incasso con deviatore.
 GB - External parts built-in shower mixer with diverter.
 FR - Parties externes monocommande douche encastrément avec inverseur.
 DE - Externe Bestandteile Einhebelmischer für Duschen Einbau mit Umstellventil.



30167..

Finiture - Finishes

CR - GI

CD

BR - RA

DB - DC - NA

DO

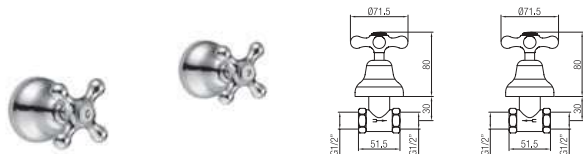

IT - Gruppo doccia incasso.
 GB - Concealed shower set.
 FR - Groupe douche encastrément.
 DE - Gruppe für Duschen Einbau.

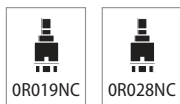

30230..

Finiture - Finishes

- CR - GI
- CD
- BR - RA
- DB - DC - NA
- DO

30530..

IT - vitone ceramica.
 GB - ceramic valve.
 FR - tête céramique.
 DE - Oberteil Keramik.

- CR - GI
- CD
- BR - RA
- DB - DC - NA
- DO

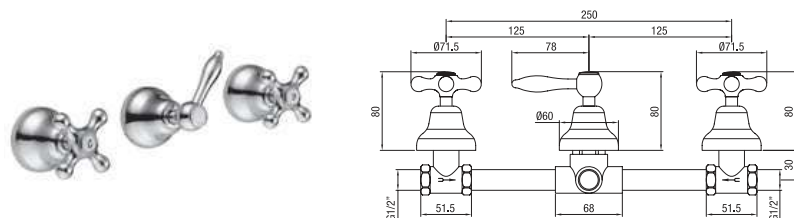

IT - Gruppo doccia incasso con deviatore.
 GB - Concealed shower set with diverter.
 FR - Groupe douche encastrément avec inverseur.
 DE - Gruppe für Duschen Einbau mit Umstellventil.

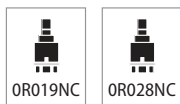

30231..

Finiture - Finishes

- CR - GI
- CD
- BR - RA
- DB - DC - NA
- DO

30531..

IT - vitone ceramica.
 GB - ceramic valve.
 FR - tête céramique.
 DE - Oberteil Keramik.

- CR - GI
- CD
- BR - RA
- DB - DC - NA
- DO

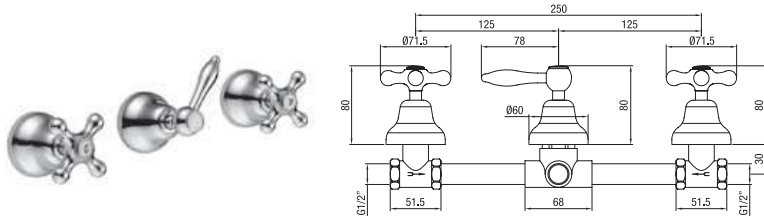

IT - Gruppo doccia incasso con deviatore tre uscite.
 GB - Concealed shower set with diverter three outlets.
 FR - Groupe douche encastré avec inverseur trois sorties.
 DE - Gruppe für Duschen Einbau mit Umstellventil 3 Ausgänge.

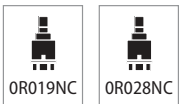

30232..

Finiture - Finishes

- CR - GI
- CD
- BR - RA
- DB - DC - NA
- DO

30532..

IT - vitone ceramica.
 GB - ceramic valve.
 FR - tête céramique.
 DE - Oberteil Keramik.

- CR - GI
- CD
- BR - RA
- DB - DC - NA
- DO

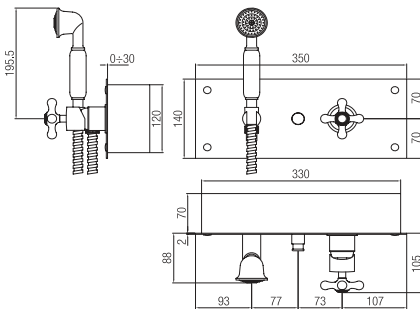

IT - Monocomando incasso doccia con deviatore e kit doccia.
 GB - Built-in shower mixer with diverter and shower kit.
 FR - Monocommande encastré douche avec inverseur et kit douche.
 DE - Einhebelmischer Einbau-Duschen mit Umstellventil und Bausatz für Duschen.



30148..

Finiture - Finishes

- CR - GI
- CD
- BR - RA
- DB - DC - NA
- DO

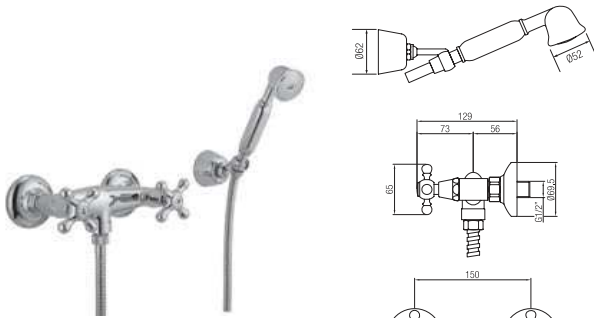

30240.. Finiture - Finishes

- CR - GI
- CD
- BR - RA
- DB - DC - NA
- DO

30540..

- IT - vitone ceramico.
 GB - ceramic valve.
 FR - tête céramique.
 DE - Oberteil Keramik.
- CR - GI
 - CD
 - BR - RA
 - DB - DC - NA
 - DO

IT - Gruppo doccia esterno con kit doccia.
 GB - External shower set with shower kit.
 FR - Groupe douche externe avec kit douche.
 DE - Externe Duschgruppe mit Bausatz für Duschen.

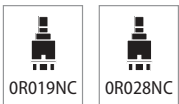

30241.. Finiture - Finishes

- CR - GI
- CD
- BR - RA
- DB - DC - NA
- DO

30541..

- IT - vitone ceramico.
 GB - ceramic valve.
 FR - tête céramique.
 DE - Oberteil Keramik.
- CR - GI
 - CD
 - BR - RA
 - DB - DC - NA
 - DO

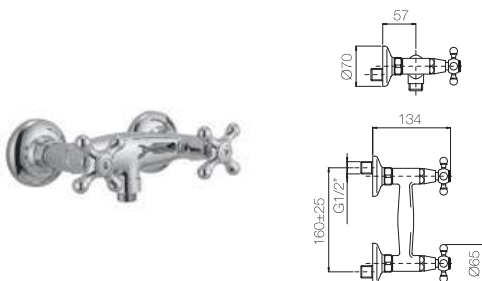

IT - Gruppo doccia esterno senza kit doccia.
 GB - External shower set without shower kit.
 FR - Groupe douche externe sans kit douche.
 DE - Externe Duschgruppe ohne Bausatz für Duschen.

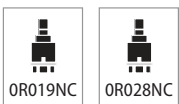

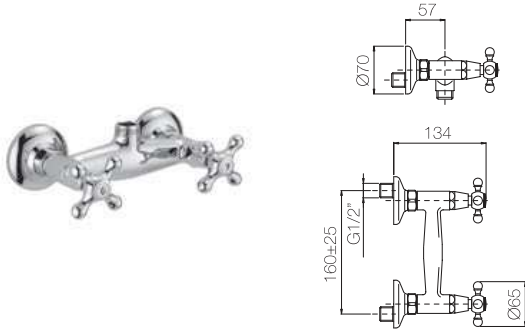

IT - Gruppo doccia esterno con attacco superiore.
 GB - External shower set with superior connection.
 FR - Groupe douche externe avec sortie supérieure.
 DE - Externe Duschgruppe mit oberem Anschluss.

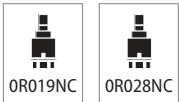

30245..

Finiture - Finishes

- CR - GI
- CD
- BR - RA
- DB - DC - NA
- DO

30545..

IT - vitone ceramico.
 GB - ceramic valve.
 FR - tête céramique.
 DE - Oberteil Keramik.

- CR - GI
- CD
- BR - RA
- DB - DC - NA
- DO

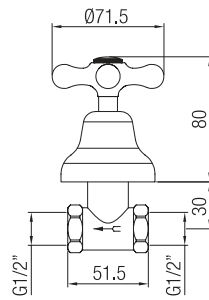

IT - Rubinetto arresto incasso 1/2".
 GB - Concealed stopcock tap 1/2".
 FR - Robinet arrêt encastrément 1/2".
 DE - Absperrarmatur Einbau 1/2".

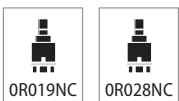

30109..

Finiture - Finishes

- CR - GI
- CD
- BR - RA
- DB - DC - NA
- DO

30509..

IT - vitone ceramico.
 GB - ceramic valve.
 FR - tête céramique.
 DE - Oberteil Keramik.

- CR - GI
- CD
- BR - RA
- DB - DC - NA
- DO

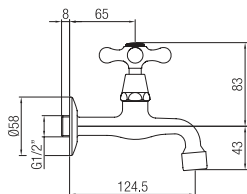

IT - Rubinetto lavello a muro 1/2"

GB - Wall sink tap 1/2"

FR - Robinet évier mural 1/2"

DE - Armatur Spülbecken Wandmontage 1/2"

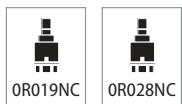

30225..

Finiture - Finishes

CR - GI

CD

BR - RA

DB - DC - NA

DO

30525..

IT - vitone ceramico.

GB - ceramic valve.

FR - tête céramique.

DE - Oberteil Keramik.

CR - GI

CD

BR - RA

DB - DC - NA

DO

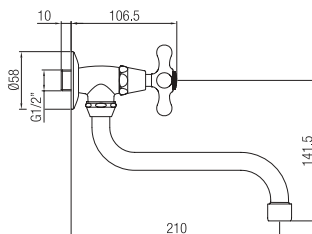

IT - Rubinetto snodo a muro 1/2"

GB - Wall joint sink tap 1/2"

FR - Robinet articulation mural 1/2"

DE - Gelenk-Wandarmatur 1/2"

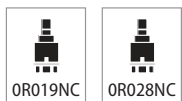

30226..

Finiture - Finishes

CR - GI

CD

BR - RA

DB - DC - NA

DO

30526..

IT - vitone ceramico.

GB - ceramic valve.

FR - tête céramique.

DE - Oberteil Keramik.

CR - GI

CD

BR - RA

DB - DC - NA

DO

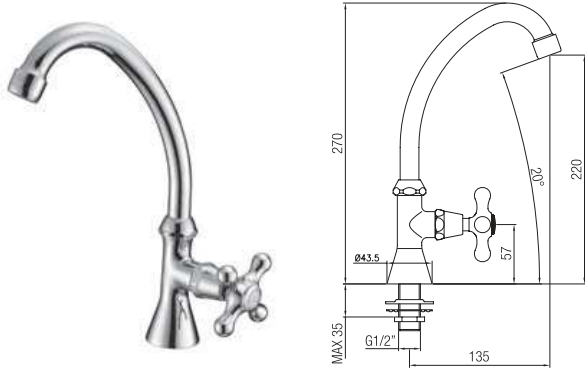

IT - Rubinetto monolavello 1/2".
 GB - Single sink tap 1/2".
 FR - Robinet mono-évier 1/2".
 DE - Armatur Mono-Spülbecken 1/2".

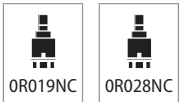

30227..

Finiture - Finishes

- CR - GI
- CD
- BR - RA
- DB - DC - NA
- DO

30527..

IT - vitone ceramico.
 GB - ceramic valve.
 FR - tête céramique.
 DE - Oberteil Keramik.

- CR - GI
- CD
- BR - RA
- DB - DC - NA
- DO



IT - Rubinetto snodo a muro 1/2" canna "U".
 GB - Wall joint sink tap 1/2" with "U" spout.
 FR - Robinet articulation mural 1/2" bec "U".
 DE - Gelenk-Wandarmatur 1/2" Auslaufrohr "U".

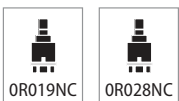

30223..

Finiture - Finishes

- CR - GI
- CD
- BR - RA
- DB - DC - NA
- DO

30523..

IT - vitone ceramico.
 GB - ceramic valve.
 FR - tête céramique.
 DE - Oberteil Keramik.

- CR - GI
- CD
- BR - RA
- DB - DC - NA
- DO

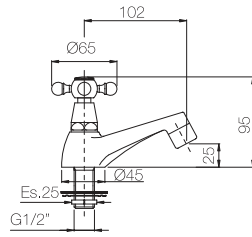

IT - Rubinetto collo cigno 1/2".
 GB - Basin pillar tap 1/2".
 FR - Robinet col de cygne 1/2".
 DE - Schwanenhalsarmatur 1/2".

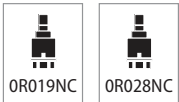

30229..

Finiture - Finishes

CR - GI

CD

BR - RA

DB - DC - NA

DO

30529..

IT - vitone ceramica.

GB - ceramic valve.

FR - tête céramique.

DE - Oberteil Keramik.

CR - GI

CD

BR - RA

DB - DC - NA

DO

PB PORTA&BINI
PASSION FOR WATER

