

GLOBO



IT - Gli articoli della serie Globo sono disponibili nelle finiture sotto indicate:

CR Cromo

IMPORTANTE: Nella cura dei prodotti Porta & Bini si devono utilizzare soltanto i prodotti di pulizia che sono espressamente previsti per questo campo d'impiego. Non utilizzare prodotti ausiliari e attrezzi per la pulizia con effetto abrasivo, come abrasivi inadatti, spugne e panni in microfibra.

GB - The articles included in Globo series are available in the following finishings:

CR Chrome

IMPORTANT: With regard to caring for the Porta & Bini products, only use cleaning material which is explicitly provided for this type of application. Never use cleaning materials or appliances with an abrasive effect, such as unsuitable cleaning powders, sponge pads or micro fibre cloths.

FR - Les articles de la série Globo sont disponibles en finitions indiquées ci-dessous :

CR Chrome

IMPORTANT : Lors de l'entretien des articles Porta & Bini, seuls les produits de nettoyage expressément prévus pour ce type d'entretien doivent être utilisés. Ne pas utiliser d'autres produits ou d'outils de nettoyage ayant un effet abrasif, tels que les abrasifs inappropriés, éponges ou chiffons en microfibre.

DE - Die Artikel der Serie Globo sind in den unten aufgeführten Fertigbearbeitungen erhältlich:

CR Chrom

WICHTIG: Für die Pflege der Produkte Porta & Bini dürfen nur die Reinigungsmittel verwendet werden, welche ausdrücklich für diesen Anwendungsbereich vorgesehen sind. Keine abrasiven Hilfsprodukte und Reinigungswerkzeuge verwenden, wie ungeeignete Schleifmittel, Schwämme und Mikrofasertücher.

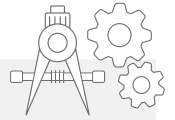

IT - SPECIFICHE TECNICHE

- > Temperatura di utilizzo massima 80°C, consigliata 60°C.
- > Pressione di alimentazione ottimale 3 bar continui.
- > Differenza pressione massima acqua calda/fredda 1 bar consigliata la minima possibile.
- > Nel caso di pressioni oltre i 5 bar, è consigliabile installare un riduttore di pressione.

NOTA: I tubetti flessibili vengono forniti come dotazione standard per una più facile installazione; i tubetti rigidi sono disponibili come un accessorio opzionale o su previa richiesta.

Per garantire l'ottimale funzionamento del prodotto si consiglia l'installazione di rubinetti filtro sottolavabo ispezionabili Porta & Bini articoli: 00538, 00539 e 00540.

GB - TECHNICAL SPECIFICATION

- > Temperature range max 80°C, recommended 60°C.
- > Optimal water supply pressure 3 bar continual.
- > Difference of hot/cold pressure max 1 bar recommended minimum possible.
- > In the event of pressure over 5 bar, install a centralized pressure reducer.

NOTE: Stainless steel hoses are provided as standard equipment for easy installation; copper supply tubes are available as an optional accessory or with advance notice.

In order to allow optimal product operation is recommended to connect hot and cold waterlines to the angle stop filter valves Porta & Bini items code: 00538, 00539 and 00540.

FR - SPÉCIFICATIONS TECHNIQUES

- > Température d'utilisation maximale 80°C, conseillée 60°C.
- > Pression d'alimentation optimale 3 bar continue.
- > Différence de pression max de l'eau chaude/froide 1 bar, la différence conseillée - la plus petite possible.
- > En cas des pressions supérieures à 5 bar, il est conseillé d'installer un réducteur de pression.

NOTE : Les tubes flexibles sont fournis avec l'équipement standard pour une installation plus facile ; les tubes rigides sont disponibles en option ou sur demande.

Afin de garantir le fonctionnement optimal du produit, il est conseillé d'installer les robinets avec filtre sous lavabo inspectables Porta & Bini articles: 00538, 00539 et 00540.

DE - TECHNISCHE SPEZIFIKATIONEN

- > Maximale Gebrauchstemperatur 80°C, empfohlene Temperatur 60°C.
- > Der optimale Versorgungsdruck liegt bei durchgehend 3 bar.
- > Als maximaler möglicher Druckunterschied bei Heiß-/Kaltwasser wird als Mindestwert 1 bar empfohlen.
- > Bei einem Wasserdruck von über 5 bar ist es ratsam, ein Druckminderventil einzubauen.

ANMERKUNG: Die Schläuche werden zur einfacheren Installation als Standardausrüstung mitgeliefert; Die starren Rohrleitungen sind als optionales Zubehör oder auf vorhergehende Anfrage erhältlich.

Um die optimale Funktionsfähigkeit des Produktes zu gewährleisten, empfiehlt sich die Installation von inspezifizierbaren Untertisch-Filtereckventilen der Firma Porta & Bini, Artikel: 00538, 00539 und 00540.

Globo

GLOBO



pag 533



pag 446

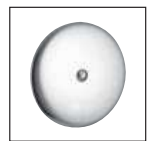

pag 567



pag 542



pag 334



pag 457



pag 316



pag 540

IT - Porta & Bini si riserva il diritto di apportare eventuali modifiche ai propri prodotti senza preavviso. Le dimensioni raffigurate all'interno delle rappresentazioni grafiche sono da ritenersi indicative e soggette a possibili variazioni. In caso di domande si prega di contattare il proprio fornitore autorizzato Porta & Bini.

GB - Porta & Bini has the right to modify its products without any notice. All dimensions are based on original specification and are subject to change and variation. Please consult your Porta & Bini Design Associate for current specifications.

FR - Porta & Bini se réserve le droit de modifier ses propres produits sans préavis. Les dimensions indiquées dans les représentations graphiques sont données à titre indicatif et sont susceptibles d'être modifiées. En cas de doutes veuillez contacter votre livreur autorisé Porta & Bini.

DE - Das Unternehmen Porta & Bini behält sich das Recht vor, Änderungen an seinen Produkten ohne vorherige Ankündigung vorzunehmen. Die in den grafischen Darstellungen dargestellten Abmessungen sind als Richtwerte zu betrachten und unterliegen möglichen Abweichungen. Bei Fragen wenden Sie sich bitte an Ihren, von Porta & Bini autorisierten Lieferanten.

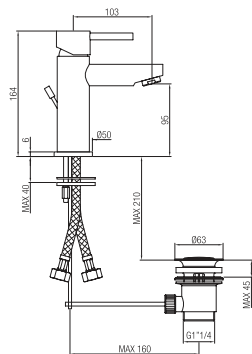

36110..

Finiture - Finishes

CR

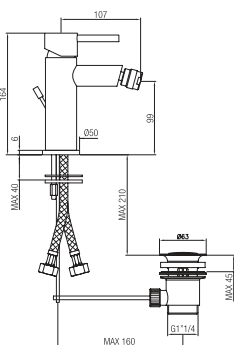

36120..

Finiture - Finishes

CR

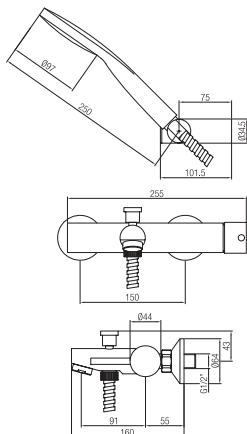

36100..

Finiture - Finishes

CR

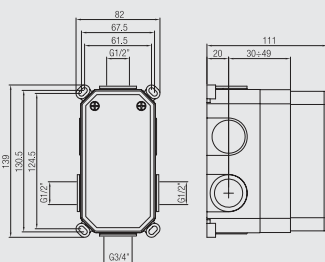

IT - Cassetta da incasso a muro universale.
 GB - Universal built-in shower box.
 FR - Boitier encastrable montage mural universel.
 DE - Universal-Einbauspülkasten Wandmontage.

01BOXNC

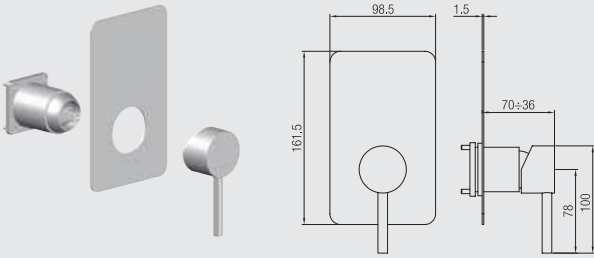

IT - Parti esterne monocomando doccia incasso.
 GB - External parts built-in shower mixer.
 FR - Parties externes monocommande douche encastrément.
 DE - Externe Bestandteile Einhebelmischer für Duschen Einbau.

 **36166..** Finiture - Finishes
CR

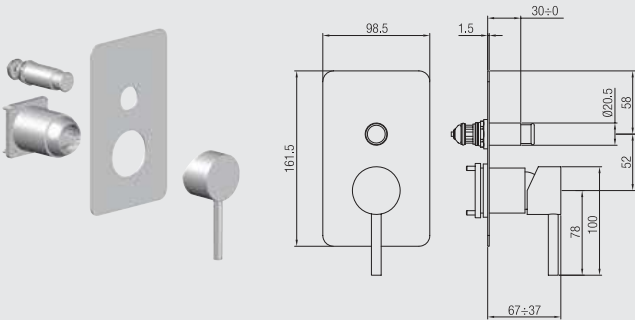

IT - Parti esterne monocomando doccia incasso con deviatore.
 GB - External parts built-in shower mixer with diverter.
 FR - Parties externes monocommande douche encastrément avec inverseur.
 DE - Externe Bestandteile Einhebelmischer für Duschen Einbau mit Umstellventil.

 **36167..** Finiture - Finishes
CR

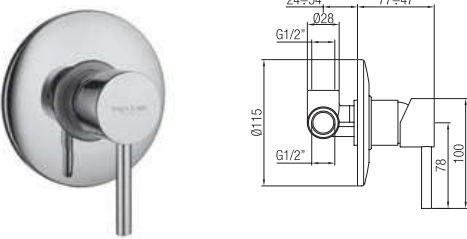

IT - Monocomando doccia incasso.
 GB - Built-in shower mixer.
 FR - Monocommande douche encastrément.
 DE - Einhebelmischer für Duschen Einbau.

 **36130..** Finiture - Finishes
CR

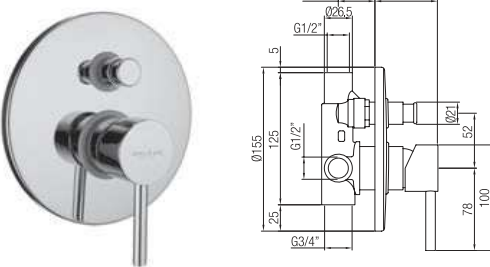

IT - Monocomando doccia incasso con deviatore.
 GB - Built-in shower mixer with diverter.
 FR - Monocommande douche encastrément avec inverseur.
 DE - Einhebelmischer für Duschen Einbau mit Umstellventil.

 **36131..** Finiture - Finishes
CR

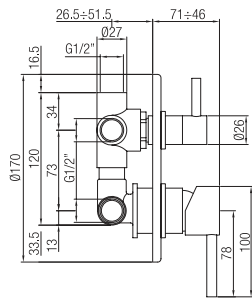

IT - Monocomando doccia incasso con deviatore tre uscite.
 GB - Built-in shower mixer with diverter three outlets.
 FR - Monocommande douche encastré avec inverseur trois sorties.
 DE - Einhebelmischer für Duschen Einbau mit Umstellventil 3 Ausgänge.



36132..

Finiture - Finishes

CR

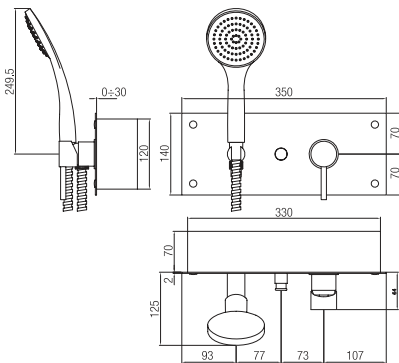

IT - Monocomando incasso doccia con deviatore e kit doccia.
 GB - Built-in shower mixer with diverter and shower kit.
 FR - Monocommande encastré douche avec inverseur et kit douche.
 DE - Einhebelmischer Einbau-Duschen mit Umstellventil und Bausatz für Duschen.



36148..

Finiture - Finishes

CR

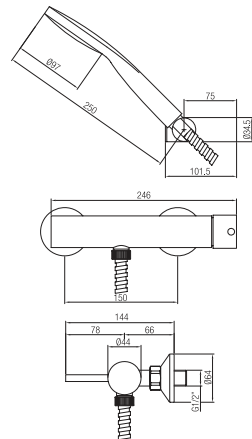

IT - Monocomando doccia esterno con kit doccia.
 GB - External shower mixer with shower kit.
 FR - Monocommande douche externe avec kit douche.
 DE - Externer Einhebelmischer für Duschen mit Bausatz für Duschen.



36140..

Finiture - Finishes

CR

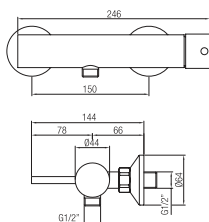

IT - Monocomando doccia esterno senza kit doccia.
 GB - External shower mixer without shower kit.
 FR - Monocommande douche externe sans kit douche.
 DE - Externer Einhebelmischer für Duschen ohne Bausatz für Duschen.



36141..

Finiture - Finishes

CR

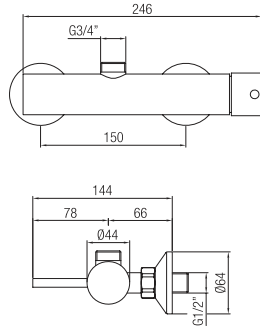

IT - Monocomando doccia esterno con attacco superiore.
 GB - External shower mixer with superior connection.
 FR - Monocommande douche externe avec sortie supérieure.
 DE - Externer Einhebelmischer für Duschen mit oberem Anschluss.



36165..

Finiture - Finishes

CR

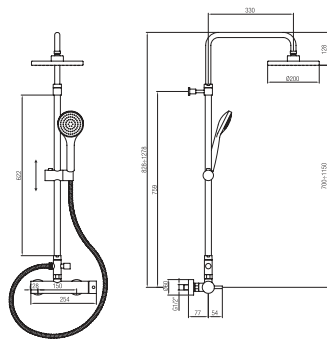

IT - Colonna doccia soffione tondo completa di miscelatore.
 GB - Complete column round head shower with external mixer.
 FR - Colonne douche, douche de tête ronde avec mitigeur.
 DE - Duschsäule Brausekopf rund vollständig di Mischbatterie.



36189..

Finiture - Finishes

CR

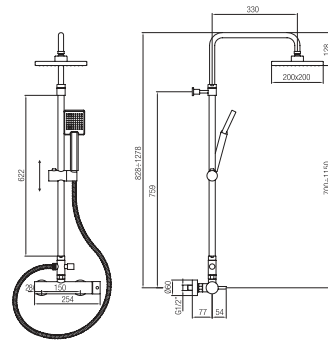

IT - Colonna doccia soffione quadro completa di miscelatore.
 GB - Complete column square head shower with external mixer.
 FR - Colonne douche, douche de tête carrée avec mitigeur.
 DE - Duschsäule Brausekopf quadratisch vollständig mit Mischbatterie.



36188..

Finiture - Finishes

CR